

RIM LOCKS – STANDARDS & SPECIFICATIONS

Pride in our American Heritage and renewed interest in its early history has greatly influenced U.S. architecture. With careful research and design, Baldwin has authentically reproduced a piece of that heritage – colonial rim locks.

- > Constructed with solid forged brass parts for exceptional durability and smooth operation
- > Trim designs secured to a broached spindle with an epoxy (resin) coated set screw – prohibits screw from loosening
- > Interior rim locks use bit keys. Bit keys may be ordered fixed permanently into the lock by ordering as .RBIT or .LBIT configurations.

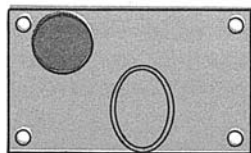
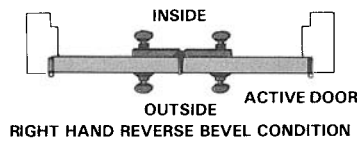
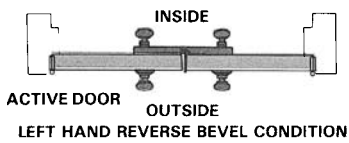
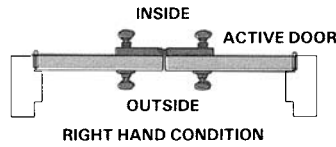
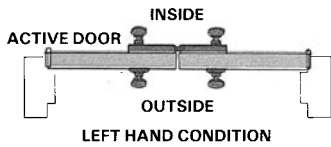
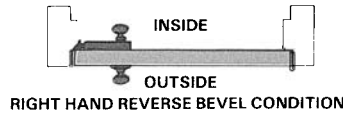
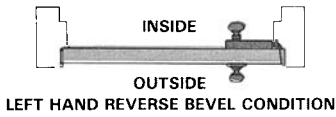
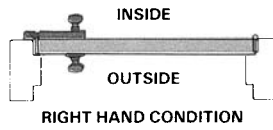
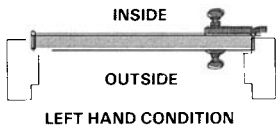
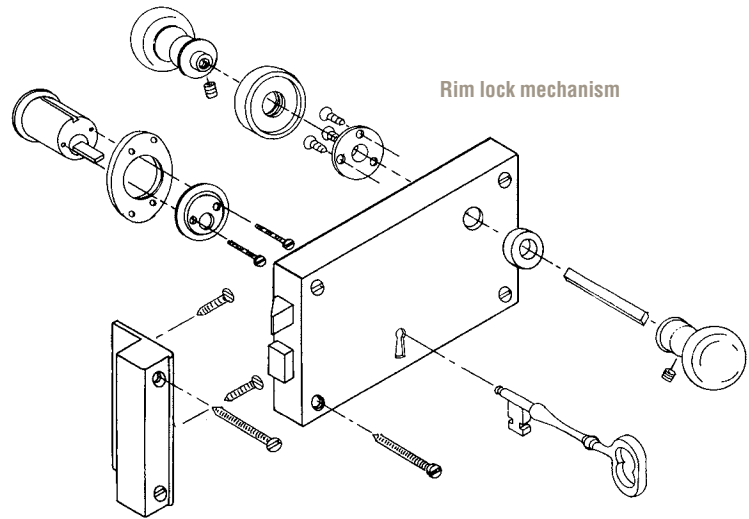

Handing of Rim Lock Plates

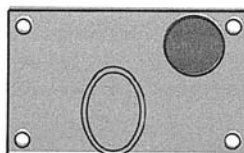

LEFT HAND CONDITION
(SINGLE DOOR)

RIGHT HAND CONDITION
(SINGLE DOOR)

NOTE: Hand of door is always determined from outside
IMPORTANT: A dummy trim rim lock must be used on ALL pairs of reverse bevel doors

RIM LOCKS – PASSAGE, PRIVACY & ENTRANCE

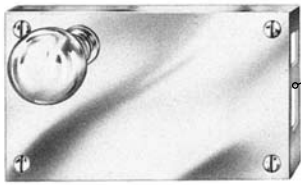

Full Dummy prepared as a strike for all function rim locks

Full Dummy Rim Locks

Hollow rim lock case (without any working mechanism)

INCLUDED:

- 5030 Knobs – pair
- 5002 Rose – half pair

Passage Rim Locks

Latch bolt by knob either side

INCLUDED:

- 5755 Bit key
Key can be permanently fitted at extra charge (.RBIT, .LBIT)
- 5030 Knobs – pair
- 5002 Rose – half pair

Privacy Rim Locks

Latch bolt by knob either side

Dead bolt by bit key either side

INCLUDED:

- 5755 Bit key – used w/ privacy function
Key can be permanently fitted at extra charge (.RBIT, .LBIT)
- 0406 Cover Plate
- 5753 Emergency key – s/b stored in readily accessible place
- 5030 Knobs – pair
- 5002 Rose – half pair

Entrance Rim Locks

Latch bolt by knob either side

Dead bolt by key outside and slide bolt inside

INCLUDED:

- 8333 Cylinder
- 6755 Cylinder Cover Plate
- 5030 Knobs – pair
- 5002 Rose – half pair



Outside Trim

- 6755.xxx Cylinder Cover (Entrance only)
- 5030.xxx Knob
- 5002.xxx Rose

030, 031, 033
038, 040, 050
060, 102, 112
150, 151, 190
260, 264

Item #	Description	Function	Wt.	Backset		
5600.xxx.R (L, .RR, .LL)	Small Vertical Rim Lock	Passage	3.7	2.75"	\$636	670
5600.xxx.RFD (LFD)	Small Vertical Rim Lock	Full Dummy	3.7	2.75"	318	335
5602.xxx.R (L, .RR, .LL)	Small Vertical Rim Lock	Privacy	4.0	2.75"	750	784
5602.xxx.RFD (LFD)	Small Vertical Rim Lock	Full Dummy	3.7	2.75"	375	392
5604.xxx.R (L, .RR, .LL)	Small Vertical Rim Lock	Entrance	4.6	2.75"	813	858
5604.xxx.RFD (LFD)	Small Vertical Rim Lock	Entrance	4.6	2.75"	407	428
5630.xxx.R (L, .RR, .LL)	7" Horizontal Rim Lock	Passage	4.4	5.25"	698	732
5630.xxx.RFD (LFD)	7" Horizontal Rim Lock	Full Dummy	4.4	5.25"	349	366
5632.xxx.R (L, .RR, .LL)	7" Horizontal Rim Lock	Privacy	4.8	5.25"	778	812
5634.xxx.R (L, .RR, .LL)	7" Horizontal Rim Lock	Entrance	5.5	5.25"	842	898
5634.xxx.RFD (LFD)	7" Horizontal Rim Lock	Entrance	5.5	5.25"	421	449
5701.xxx.R (L, .RR, .LL)	Small Horizontal Rim Lock	Passage	3.8	3.5"	636	670
5701.xxx.RFD (LFD)	Small Horizontal Rim Lock	Full Dummy	3.8	3.5"	318	335
5702.xxx.R (L, .RR, .LL)	Small Horizontal Rim Lock	Privacy	4.2	3.5"	750	784
5702.xxx.RFD (LFD)	Small Vertical Rim Lock	Full Dummy	3.7	3.5"	375	392
5704.xxx.R (L, .RR, .LL)	Small Horizontal Rim Lock	Entrance	4.6	3.5"	813	858
5704.xxx.RFD (LFD)	Small Horizontal Rim Lock	Entrance	4.6	3.5"	407	428

RIM LOCKS ARE NOT REVERSIBLE – SPECIFY HAND OF DOORS

IMPORTANT: A dummy trim rim lock must be used on ALL pairs of reverse bevel doors

Bit Key can be permanently fitted at an extra charge of \$10

(add 'BIT' to end of suffix: eg. 5600.xxx.R becomes 5600.xxx.RBIT)

Inside Trim



Right Hand Shown

5600, 5602, 5604.xxx – Small Vertical Rim Lock

- CASE: 4.75" x 3.75" x .875"
- KEEPER: 4.75" x .875" x 1.625"
- BACKSET: 2.75"

Upright design well suited for narrow stile doors

Inside Trim

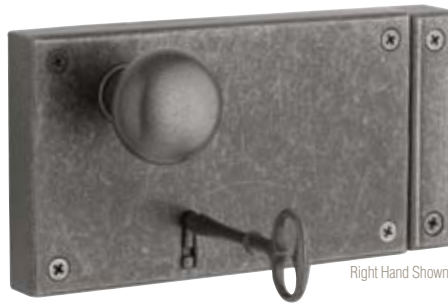

Right Hand Shown

5630, 5632, 5634.xxx – 7" Horizontal Rim Lock

- CASE: 4" x 6.75" x .875"
- KEEPER: 4" x .875" x 1.625"
- BACKSET: 5.25"

Inside Trim



Left Hand Shown

5701, 5702, 5704.xxx – Small Horizontal Rim Lock

- CASE: 3.75" x 4.75" x .875"
- KEEPER: 3.75" x .875" x 1.625"
- BACKSET: 3.5"
- TO BIT KEY: 2.375"

RIM LOCKS – ENTRANCE, SPECIAL FUNCTION

Item #	Description	Function	Wt.	Backset	030, 031, 033 038, 040, 050 060, 102, 112 150, 151, 190 260, 264	003 055 056
5636.xxx.R (L, .RR, .LL)	Bevelled Rim Lock	Entrance	7.2	5.25"	\$1,127	1,206
5636.xxx.RFD (.LFD)	Bevelled Rim Lock	Entrance	7.2	5.25"	563	604
5639.xxx.R (L, .RR, .LL)	Hollow Metal Doors Rim Lock	Entrance	7.2	5.25"	1,127	1,206
5639.xxx.RFD (.LFD)	Hollow Metal Doors Rim Lock	Entrance	7.2	5.25"	563	604
5644.xxx.R (L, .RR, .LL)	Horizontal Cylinder Lock	Entrance	7.9	8"	1,127	1,206
5644.xxx.RFD (.LFD)	Horizontal Cylinder Lock	Entrance	7.9	8"	563	604
5720.xxx.R (L, .RR, .LL)	Entrance Door Rim Lock	Entrance	7.8	3.5"	1,127	1,206
5720.xxx.RFD (.LFD)	Entrance Door Rim Lock	Entrance	7.8	3.5"	563	604
5722.xxx	Entrance Door Rim Lock	Outside only	x	3.5"	327	389
5723.xxx.R (L)	Entrance Door Rim Lock	Inside only	x	3.5"	869	892

RIM LOCKS ARE NOT REVERSIBLE – SPECIFY HAND OF DOORS

IMPORTANT: A dummy trim rim lock must be used on ALL pairs of reverse bevel doors

Bit Key can be permanently fitted at an extra charge of \$10

(add 'BIT' to end of suffix: eg. 5600.xxx.R becomes 5600.xxx.RBIT)

Inside Trim



5636.xxx Bevelled Rim Lock

CASE: 5" x 7.25" x .875"
 KEEPER: 5" x 1.375" x 1.625"
 BACKSET: 5.25"
 TO BIT KEY: 4"
 FRONT TO CYLINDER CENTERLINE: 3"

Latch bolt by knob either side
 Dead bolt by key outside and slide bolt inside

INCLUDED:

- 8333 Cylinder
- 6755 Cylinder Cover Plate
- 5755 Bit key – used w/ privacy function
- Key can be permanently fitted at extra charge
- 5030 Knobs – pair
- 5002 Rose – half pair

Inside Trim



5644.xxx – Horizontal Cylinder Lock

CASE: 5.75" x 10" x .875"
 KEEPER: 5.75" x .875" x 1.625"
 BACKSET: 8"
 TO BIT KEY: 6"
 FRONT TO CYLINDER CENTERLINE: 5"

Latch bolt by knob either side
 Dead bolt by key outside and slide bolt inside

INCLUDED:

- 8333 Cylinder
- 6755 Cylinder Cover Plate
- 5755 Bit key – used w/ privacy function
- Key can be permanently fitted at extra charge
- 5030 Knobs – pair
- 5002 Rose – half pair

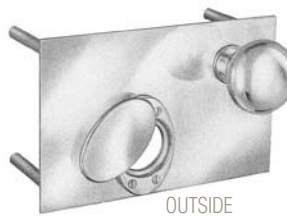

OUTSIDE

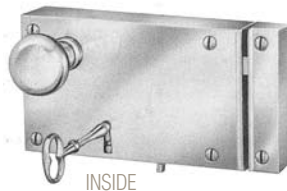

INSIDE

5639.xxx – Hollow Metal Door Rim Lock

CASE: 4" x 6.75" x .875"
 KEEPER: 4" x .875" x 1.625"
 LOCK PLATE: 4" x 6.25"
 BACKSET: 5.25"
 TO BIT KEY: 4"
 FRONT TO CYLINDER CENTERLINE: 3"

NOTE: For 1.75" thick doors only
 Specially fabricated lock plate for metal clad doors

Latch bolt by knob either side
 Dead bolt by key outside and slide bolt inside

INCLUDED:

- 8333 Cylinder
- 6755 Cylinder Cover Plate
- 5755 Bit key – used w/ privacy function
- Key can be permanently fitted at extra charge
- 0579 Filler Plate
- 5629 Lock Plate
- 5030 Knobs – pair

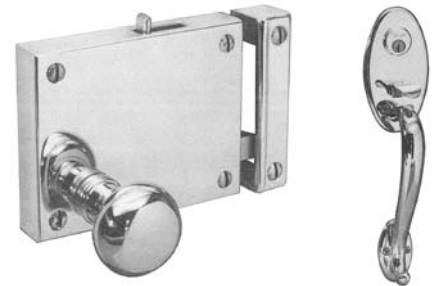

5720.xxx – Entrance Door Rim Lock

CASE: 3.75" x 4.75" x .875"
 KEEPER: 3.75" x .875" x 1.625"
 BACKSET: 3.5"
 FRONT TO CYLINDER CENTERLINE: 2.75"

NOTE: For 1.75" - 2" thick doors only
 Latch bolt by knob either side
 Dead bolt by key outside and slide bolt inside

Unusual combination of classic colonial "Pitcher Handle" sectional trim outside with Early American rim lock inside. Thumb piece operates latch and can be locked by turning cylinder key from outside or sliding dead bolt from inside.

INCLUDED:

- 5722 Outside Trim – Pitcher Handle
- 5723 Inside Trim – Rim Lock
- 8333 Cylinder
- 5030 Knob – half pair

RIM LOCKS – TRIM

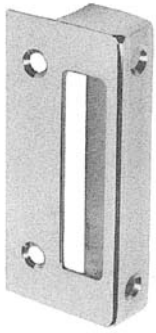

Rim Lock Keepers (Strikes)

5601	4.75" x .875" x 1.625"
5631	4" x .875" x 1.625"
5641	5.75" x .875" x 1.625"
5671	3.75" x .875" x 1.625"

Fits Rim Locks

5600, 5602, 5604
5630, 5632, 5634, 5639
5644
5701, 5702, 5704, 5720

030, 031, 033
038, 040, 050
060, 102, 112
150, 151, 190
260, 264

003
055
056

Item #	Description	Fits		
5601.xxx	Keeper (Standard Strike)	5600, 5602, 5604		
5631.xxx	Keeper (Standard Strike)	5630, 5632, 5634, 5639	\$67	72
5641.xxx	Keeper (Standard Strike)	5644		
5671.xxx	Keeper (Standard Strike)	5701, 5702, 5704, 5720		
<hr/>				
5603.xxx	Reverse Bevel Keeper (Strike)	5600, 5602, 5604		
5628.xxx	Reverse Bevel Keeper (Strike)	5630, 5632, 5634, 5639	\$57	62
5642.xxx	Reverse Bevel Keeper (Strike)	5644		
5672.xxx	Reverse Bevel Keeper (Strike)	5701, 5702, 5704, 5720		
<hr/>				
5606.xxx	Scuff Plate	5600, 5602, 5604		
5633.xxx	Scuff Plate	5630, 5632, 5634, 5639	\$57	62
5643.xxx	Scuff Plate	5644		
5673.xxx	Scuff Plate	5701, 5702, 5704, 5720		
<hr/>				
5608.xxx	Exterior Lock Plate	5604		
5626.xxx	Exterior Lock Plate	5634, 5636	\$125	136
5629.xxx	Exterior Lock Plate	5639		
5674.xxx	Exterior Lock Plate	5704		

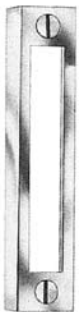

REVERSE BEVEL STRIKE

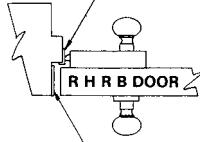

SCUFF PLATE

Reverse Bevel Keepers (Strikes)

5603	4.75" x 1" x .375"
5628	4" x 1" x .375"
5642	5.75" x 1" x .375"
5672	3.75" x 1" x .375"

Fits Rim Locks

5600, 5602, 5604
5630, 5632, 5634, 5639
5644
5701, 5702, 5704, 5720



Scuff Plates

Recommended on reverse bevel doors.
Prevents damage to doors and latch bolts.
Provides smoother lock operation.

5606	4.75" x 1.875"
5633	4" x 1.875"
5643	5.75" x 1.875"
5673	3.75" x 1.875"

Fits Rim Locks

5600, 5602, 5604
5630, 5632, 5634, 5639
5644
5701, 5702, 5704, 5720

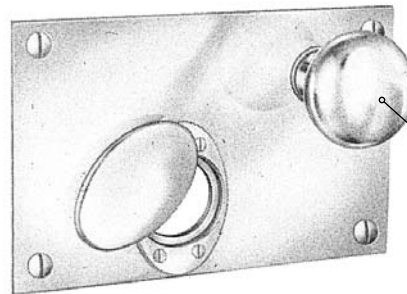

Knob trim NOT included
Included with Cylinder-function Rim Lock

5608-5674.xxx – Exterior only Lock Plate

Item #	Door handing	Door	Plate Prep	Size	Fits Rim Lock
5608.xxx.RSKC (.LSKC)*	R or L	S (Single)	KC	4.75" x 3.25"	5604
5626.xxx.RSKC (.LSKC)**	R or L	S	KC	4" x 6.25"	5634, 5636
5629.xxx.RSKC (.LSKC)	R or L	S	KC	4" x 6.25"	5639
5674.xxx.RSKC (.LSKC)*	R or L	S	KC	3.75" x 4.25"	5704

*Does not include and cannot accommodate 6755 Swing Cover

**Beveled trim for 5626 lock plate is not available.

5626 & 5629 PLATES: 6755 Cylinder Cover Plate is secured to plate

NOTE: Rose and Cylinder trim furnished with cylinder function rim locks not used w/ Lock Plate

THICKNESS: .093"

RIM LOCKS – ACCESSORIES



0406.xxx – Colonial Emergency Release Trim & Key
 SIZE: 2.312" × .687" (59 × 17mm).



5753.xxx – Emergency Release Key
 SIZE: 4" (102mm) long.
 Designed for use with Privacy Rim and Mortise Lock



6755.xxx – Cylinder Cover Plate
 SIZE: 2.375" × 1.625" (60 × 41mm)
 FEATURES: For use with all standard rim lock cylinders (except 5704 Rim Lock)



5754.xxx – Key Plate
 SIZE: 2" × 1.125" (51 × 29mm), Key Plate



6755.xxx.001-3 – Blocking Rings
 For 6755 Cylinder Cover Plate only

8314.xxx – Wrought Cylinder Collar for Rim Locks

Item #	Description	030, 031, 033	003
		038, 040, 050	
		060, 102, 112	055
		150, 151, 190	056
		260, 264	
0406.xxx	Colonial Emergency Release Trim & Key	\$33	36
5753.xxx	Emergency Release Key	30	32
5754.xxx	Key Plate	14	18
5755.xxx	Bit Key	32	36
5758.xxx	Solid Brass Spacer	10	12
6755.xxx	Cylinder Lock Cover Plate	85	98
6755.xxx.001	1/16" Blocking Ring – 6755 only (040 finish only)	8	
6755.xxx.002	3/32" Blocking Ring – 6755 only (040 finish only)	8	
6755.xxx.003	1/8" Blocking Ring – 6755 only (040 finish only)	8	
8314.xxx	Wrought Cylinder Collar for Rim Locks	10	12

5755.xxx Bit Key

SIZE: 4" (102mm) long.
 FEATURES: Fits all Baldwin rim locks. Can be permanently fitted with locks to prevent unauthorized removal.

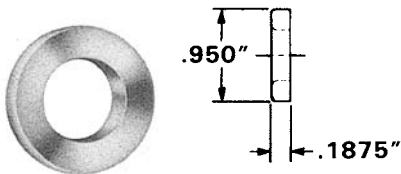

5758.xxx – Solid Brass Spacer
 Designed for use with knob trim during installation on rim lock case.
 Furnished standard with all rim lock sets.